

## Specification

- ☞ Comply with EIA-310-E, IEC297-2, DIN41491 PART1, DIN41494 PART7, GB/T3074.2-92 Standard.
- ☞ Various sizes and parts are available according to different application demand.
- ☞ Completely welded structure, firm and reliable.
- ☞ Cable in/out access at the top, bottom and rear for convenient cabling on site.
- ☞ High quality powder coated.
- ☞ Various optional accessories.
- ☞ Easy to assemble.
- ☞ Providing several copper grounding stud.
- ☞ Adjustable feet.
- ☞ Color option, black, white, gray.
- ☞ 15U, 600x600x770, max static loading 60 kg.



perforated frame, excellent cooling



front door with security locks, easily use



U numbering marked mounting rail



Detachable side panels, can be locked.



The design of back panel is convenient to install the wall



The top and bottom stripes are detachable to facilitate wiring.

- ① Wall mounting plate
- ② Back panel
- ③ Top panel
- ④ Frame
- ⑤ Mounting Rails
- ⑥ Side panel
- ⑦ Bottom panel
- ⑧ E Door
- ⑨ C Door
- ⑩ B Door
- ⑪ A Door

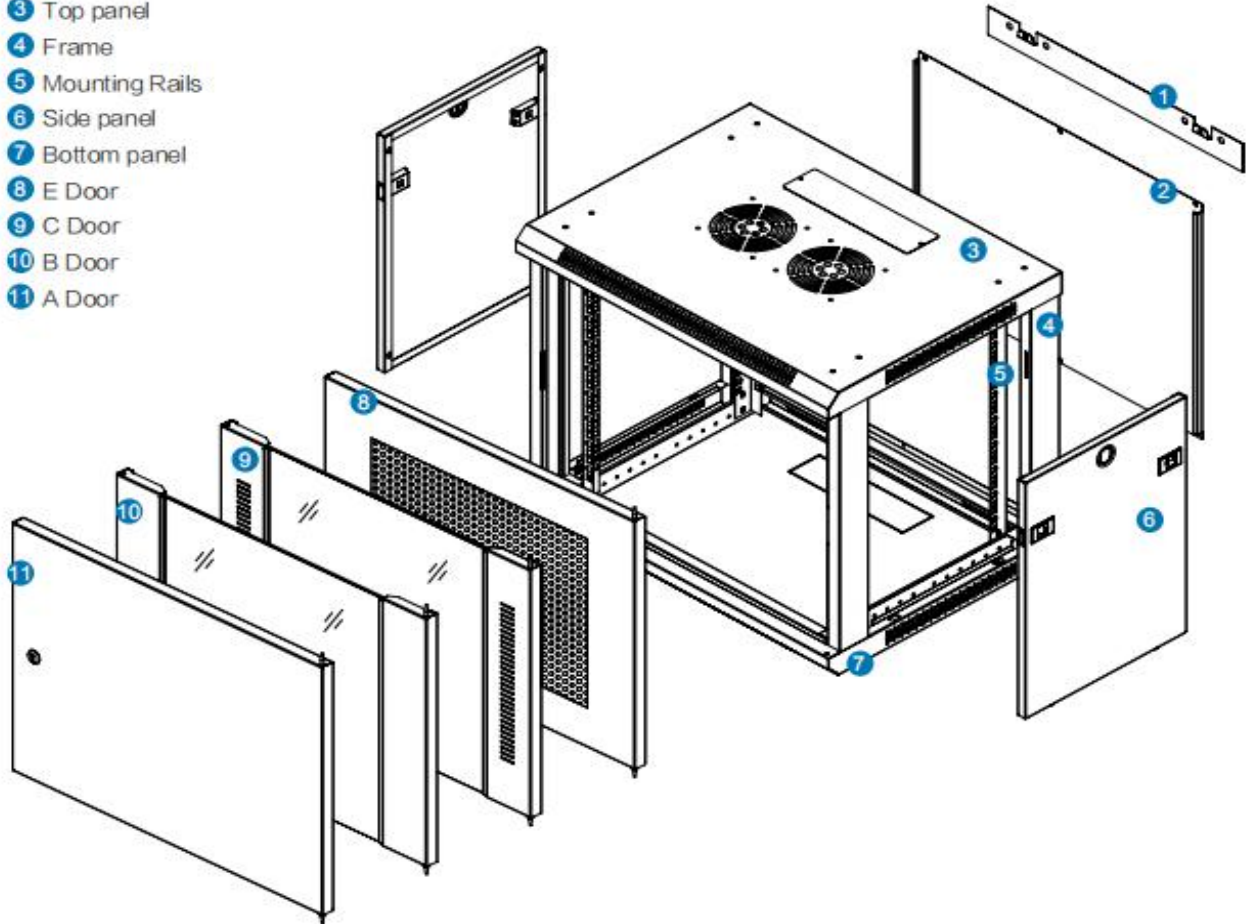

S/N	Part name	Quantity	Unit	Material	Surface finish	Remark
1	Top panel	1	Piece	SPCC cold rolled steel t1.2	powder coated	---
2	Bottom panel	1	Piece	SPCC cold rolled steel t1.2	powder coated	---
3	Frame	2	Piece	SPCC cold rolled steel t1.2	powder coated	---
4	mounting beam	4	Piece	SPCC cold rolled steel t1.2	powder coated	---
5	Vertical mounting rails	4	Piece	SPCC cold rolled steel t1.5	powder coated	---
6	wall mounting plate	1	Piece	SPCC cold rolled steel t1.2	powder coated	---
7	back panel	1	Piece	SPCC cold rolled steel t1.2	powder coated	---
8	Front door	1	Piece	---	powder coated	---
9	Side panel	2	Piece	SPCC cold rolled steel t0.8	powder coated	---
10	wafer locks	1	Piece	Zinc alloy	electroplate nickel	With 1 keys
11	M6 Screw and nut sets	10	Set	---	---	---
12	spanner	1	Piece	---	---	---
13	Inner hexagon spanner	1	Piece	---	---	---